

Adapter-Satz für Bremsen-Entlüfter

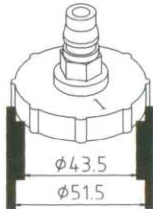

ADAPTER

1



Ø 43,5 mm

Chrysler, Dodge Jeep, Plymouth

2

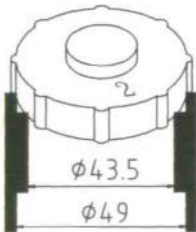

Ø 43,5 mm

Chrysler, Dodge, Jeep, Plymouth

3

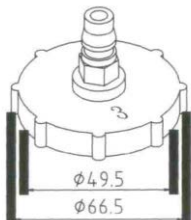

Ø 49,5 mm

GM, Buick, Cadillac, Chevrolet, GMC, Hummer,
Oldsmobile, Pontiac, einige Mazda

4

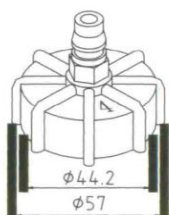



Ø 44,2 mm

BMW, Audi, EU-Fahrzeuge

5  \varnothing 45 mm EU-Fahrzeuge

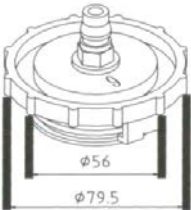
6  \varnothing 42 mm
Euro-Adapter
Alfa Romeo, Audi, BMW, Jaguar, Land Rover,
Mercedes, Peugeot, Porsche, Renault, Saab, VW,
Volvo, Chrysler Crossfire, Daewoo, Ford, KIA, einige
Mazda und Mini

9  \varnothing 56 mm Honda

10  \varnothing 34,5 mm Nissan

Universal-Adapter 7

inkl. einem Druckstück, 2x Gewindebolzen, 2x Rändelmuttern und einer Kette.

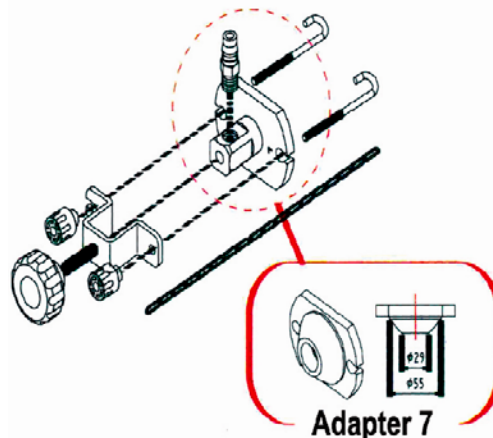

Brake Bleeding Adaptor Set



ADAPTOR

1

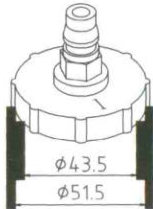

Ø 43.5 mm

Chrysler, Dodge Jeep, Plymouth

2

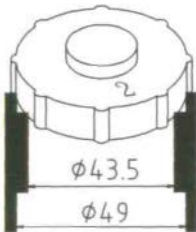

Ø 43.5 mm

Chrysler, Dodge, Jeep, Plymouth

3

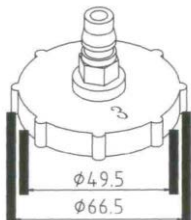

Ø 49.5 mm

GM, Buick, Cadillac, Chevrolet, GMC, Hummer,
Oldsmobile, Pontiac, some Mazda models

4

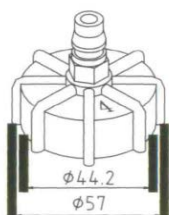



Ø 44.2 mm

BMW, Audi, european vehicles

5  \varnothing 45 mm European Vehicles

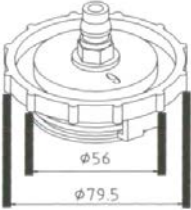
6  \varnothing 42 mm European Adaptor
Alfa Romeo, Audi, BMW, Jaguar, Land Rover,
Mercedes, Peugeot, Porsche, Renault, Saab, VW,
Volvo, Chrysler Crossfire, Daewoo, Ford, KIA, some
Mazda and Mini

9  \varnothing 56 mm Honda

10  \varnothing 34.5 mm Nissan

Universal Adapter 7

including a pressure plate, 2x studs, 2x collars and a chain.

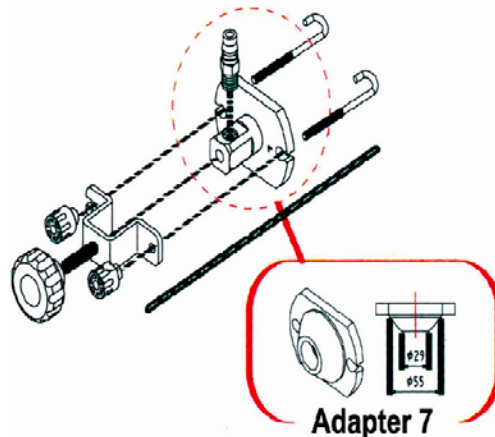

Jeu d'adaptateurs pour purgeur de frein



ADAPTATEUR

1

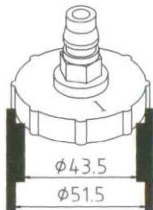

Ø 43,5 mm

Chrysler, Dodge Jeep, Plymouth

2

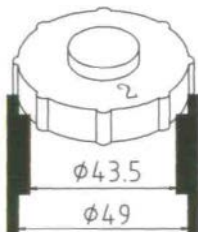

Ø 43,5 mm

Chrysler, Dodge, Jeep, Plymouth

3

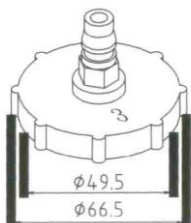

Ø 49,5 mm

GM, Buick, Cadillac, Chevrolet, GMC, Hummer, Oldsmobile, Pontiac, un peu de Mazda

4

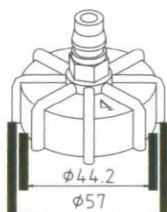



Ø 44,2 mm

BMW, Audi, Véhicules de l'UE

5  Ø 45 mm Véhicules de l'UE

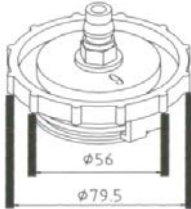
6  Ø 42 mm Adaptateur euro
Alfa Romeo, Audi, BMW, Jaguar, Land Rover,
Mercedes, Peugeot, Porsche, Renault, Saab, VW,
Volvo, Chrysler Crossfire, Daewoo, Ford, KIA, un peu
de Mazda et Mini

9  Ø 56 mm Honda

10  Ø 34,5 mm Nissan

Adaptateur universel 7

Y compris une pièce de pression, 2x boulons filetés, 2x écrous moletés et une chaîne.

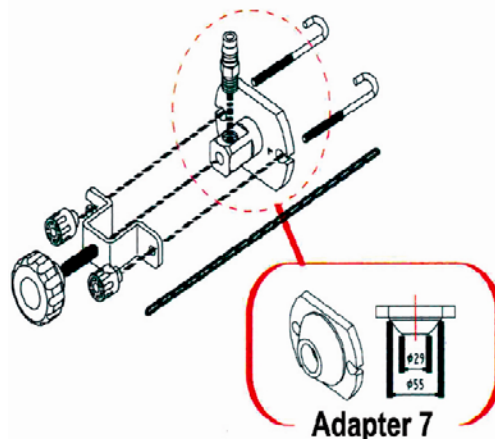

Set di adattatori per spurgo freno**ADATTATORI**

1

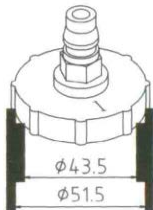
 $\text{\O} 43.5 \text{ mm}$

Chrysler, Dodge Jeep, Plymouth

2

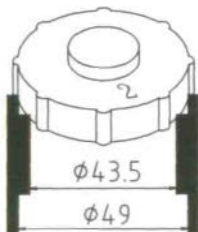
 $\text{\O} 43.5 \text{ mm}$

Chrysler, Dodge, Jeep, Plymouth

3

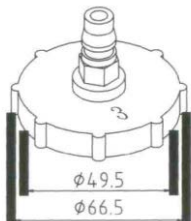
 $\text{\O} 49.5 \text{ mm}$ GM, Buick, Cadillac, Chevrolet, GMC, Hummer,
Oldsmobile, Pontiac, alcuni modelli Mazda

4

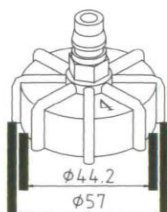
 $\text{\O} 44.2 \text{ mm}$

BMW, Audi, Veicoli europei

5

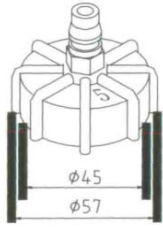

Ø 45 mm

Veicoli europei

6



Ø 42 mm

Adattatore per l'Europa
Alfa Romeo, Audi, BMW, Jaguar, Land Rover,
Mercedes, Peugeot, Porsche, Renault, Saab, VW,
Volvo, Chrysler Crossfire, Daewoo, Ford, KIA, alcuni
modelli Mazda e Mini

9

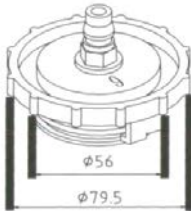

Ø 56 mm

Honda

10



Ø 34.5 mm

Nissan

7 Adattatori universali

Inclusa una piastra per la pressione, 2x chiodi, 2x fascette e una catena.

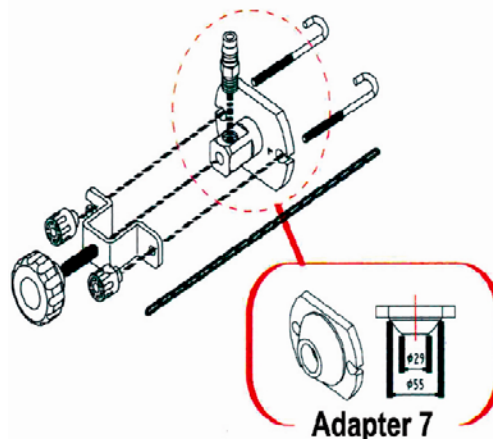

Juego de adaptadores para frenos sangrantes



ADAPTADORES

1

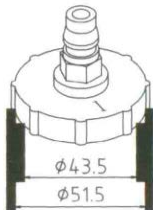

Ø 43,5 mm

Chrysler, Dodge Jeep, Plymouth

2

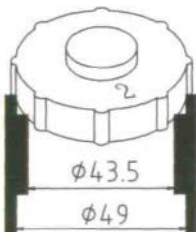

Ø 43,5 mm

Chrysler, Dodge, Jeep, Plymouth

3

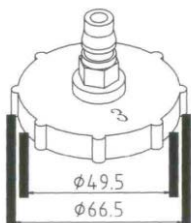

Ø 49,5 mm

GM, Buick, Cadillac, Chevrolet, GMC, Hummer, Oldsmobile, Pontiac, algunos modelos Mazda

4

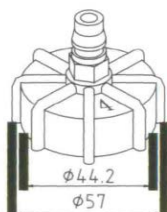

Ø 44,2 mm

BMW, Audi, Vehículos de la UE

5

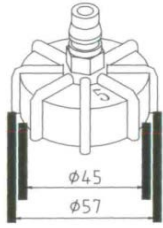

Ø 45 mm

Vehículos de la UE

6

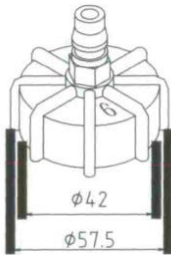

Ø 42 mm

Adaptador euro
Alfa Romeo, Audi, BMW, Jaguar, Land Rover,
Mercedes, Peugeot, Porsche, Renault, Saab, VW,
Volvo, Chrysler Crossfire, Daewoo, Ford, KIA, algunos
modelos Mazda y Mini

9

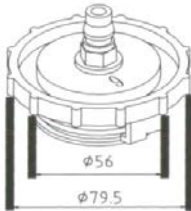

Ø 56 mm

Honda

10



Ø 34,5 mm

Nissan

Adaptador universal 7

Incluye una pieza de presión, 2 tornillos roscados, 2 tuercas moleteadas y una cadena.

